

V Belt Pulley Catalogue

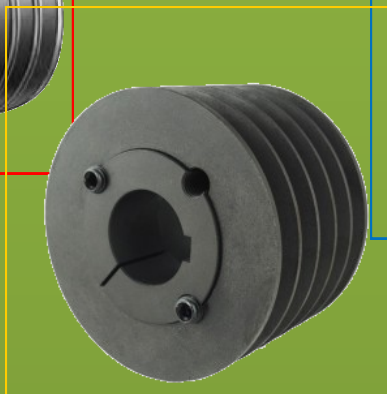

V BELT PULLEY

The standard V-Belt drives have been around for more than 50 Years. It is used in machines through out industry and is one of the most recognized belt drives ever made. The SPA, SPB, SPC & SPZ series are the new and improved version of V-belt drives. It is capable of greater power than the A,B,C & D sections thus giving you a more compact drive.

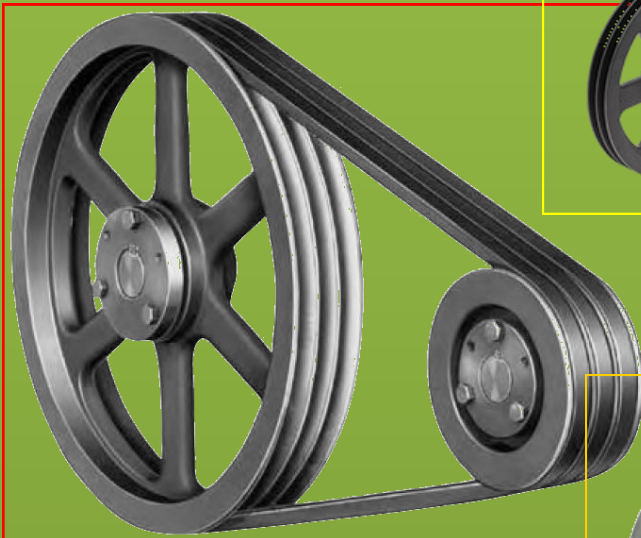
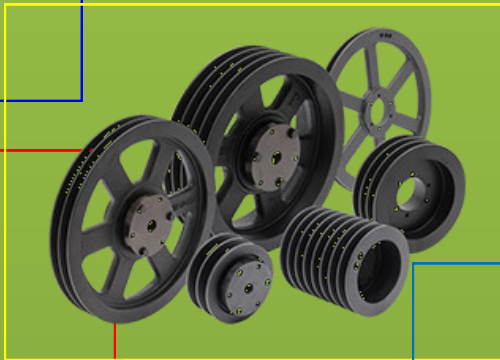
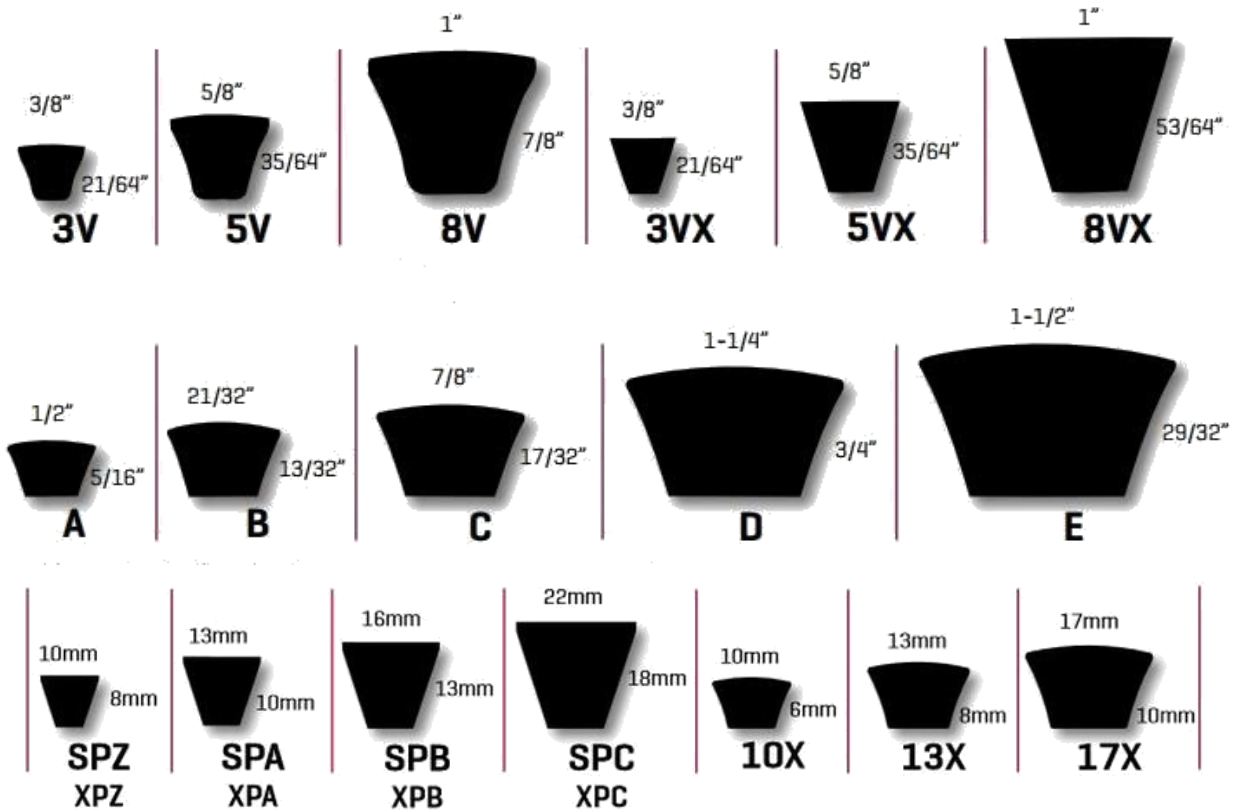

Sizing up a Pulley

To size up a V pulley following information must be known:
 Belt Profile: A, B, C, D, E, SPA, SPB, SPC, SPZ
 Grooves: Number of Grooves
 P.D. or O.D. : The pitch diameter of the pulley or outside diameter of the pulley.

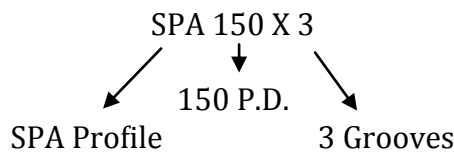

Sizing up a Belt

To size up a V Belt following information must be known:
 Belt Profile: A, B, C, D, E, SPA, SPB, SPC, SPZ
 Belt Length : The Length of the belt expressed in millimetres or inch.

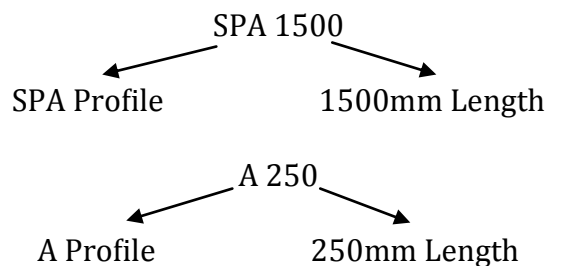

SPA Taper Bore V Pulley 1 Groove



Delivering Quality Since 1997

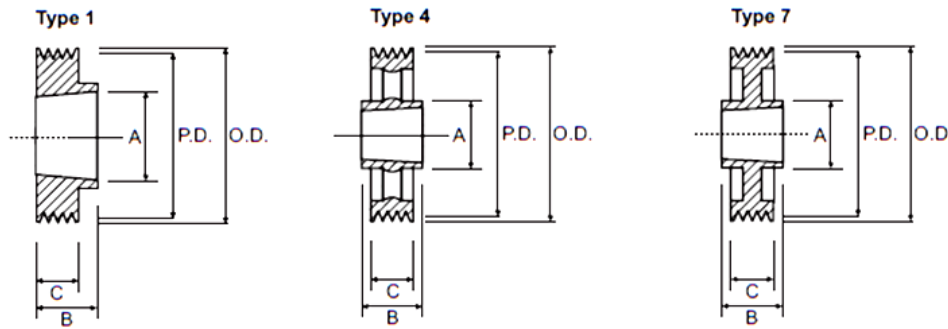

Part No.	O.D.	Type	Bush	A	B
SPA-80mm x 1	85.5	1	1210	75	25
SPA-85mm x 1	90.5	1	1210	80	25
SPA-90mm x 1	95.5	1	1210	80	25
SPA-95mm x 1	100.5	1	1210	85	25
SPA-100mm x 1	105.5	1	1610	85	25
SPA-106mm x 1	111.5	1	1610	92	25
SPA-112mm x 1	117.5	1	1610	92	25
SPA-118mm x 1	123.5	1	1610	92	25
SPA-125mm x 1	130.5	1	1610	92	25
SPA-132mm x 1	137.5	1	1610	92	25
SPA-140mm x 1	145.5	1	1610	92	25
SPA-150mm x 1	155.5	1	1610	92	25
SPA-160mm x 1	165.5	1	1610	92	25
SPA-170mm x 1	175.5	1	1610	92	25
SPA-180mm x 1	185.5	1	1610	92	25
SPA-190mm x 1	195.5	1	1610	92	25
SPA-200mm x 1	205.5	7	2012	108	32
SPA-224mm x 1	229.5	7	2012	112	32
SPA-236mm x 1	241.5	7	2012	112	32
SPA-250mm x 1	255.5	7	2012	112	32
SPA-280mm x 1	285.5	7	2012	112	32
SPA-315mm x 1	320.5	4	2012	112	32
SPA-355mm x 1	360.5	4	2012	112	32
SPA-400mm x 1	405.5	4	2012	112	32
SPA-500mm x 1	505.5	4	2517	124	45

Pitch Diameter = Outside Diameter - 5.5 mm

'C' = 20mm

- We supply Pulleys in straight bore with keyway as per customer requirements
- Material: C.I., M.S., Aluminium, Cast Aluminium, or other as per requirement
- We also manufacture all sizes which are not provided in table above.
- Customer Drawings and Specifications are most preferable.
- Pulley Type, Bush number, O.D., Bore, Width etc. will be as per customer design.
- We manufacture pulley in any type, any diameter, any no of groove as required.

SPA Taper Bore V Pulley 2 Groove

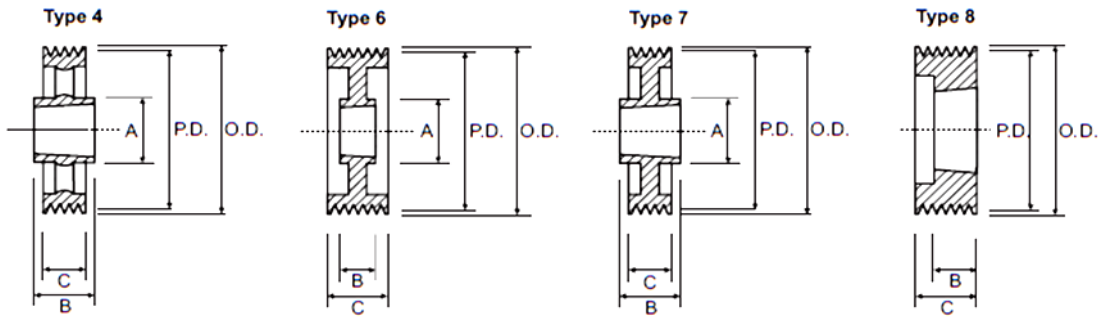

Part No.	O.D.	Type	Bush	A	B
SPA-80mm x 2	85.5	8	1210	-	25
SPA-85mm x 2	90.5	8	1210	-	25
SPA-90mm x 2	95.5	8	1610	-	25
SPA-95mm x 2	100.5	8	1610	-	25
SPA-100mm x 2	105.5	8	1610	-	25
SPA-106mm x 2	111.5	8	1610	-	25
SPA-112mm x 2	117.5	8	1610	-	25
SPA-118mm x 2	123.5	8	1610	-	25
SPA-125mm x 2	130.5	8	1610	-	25
SPA-132mm x 2	137.5	8	2012	-	32
SPA-140mm x 2	145.5	8	2012	-	32
SPA-150mm x 2	155.5	8	2012	-	32
SPA-160mm x 2	165.5	6	2012	108	32
SPA-170mm x 2	175.5	6	2012	108	32
SPA-180mm x 2	185.5	6	2012	108	32
SPA-190mm x 2	195.5	6	2012	108	32
SPA-200mm x 2	205.5	7	2517	124	45
SPA-224mm x 2	229.5	7	2517	124	45
SPA-236mm x 2	241.5	7	2517	120	45
SPA-250mm x 2	255.5	7	2517	124	45
SPA-280mm x 2	285.5	7	2517	124	45
SPA-315mm x 2	320.5	4	2517	124	45
SPA-355mm x 2	360.5	4	2517	124	45
SPA-400mm x 2	405.5	4	2517	124	45
SPA-500mm x 2	505.5	4	2517	124	45

Pitch Diameter = Outside Diameter - 5.5 mm

'C' = 35mm

- We supply Pulleys in straight bore with keyway as per customer requirements
- Material: C.I., M.S., Aluminium, Cast Aluminium, or other as per requirement
- We also manufacture all sizes which are not provided in table above.
- Customer Drawings and Specifications are most preferable.
- Pulley Type, Bush number, O.D., Bore, Width etc. will be as per customer design.
- We manufacture pulley in any type, any diameter, any no of groove as required.

SPA Taper Bore V Pulley 3 Groove



Delivering Quality Since 1997

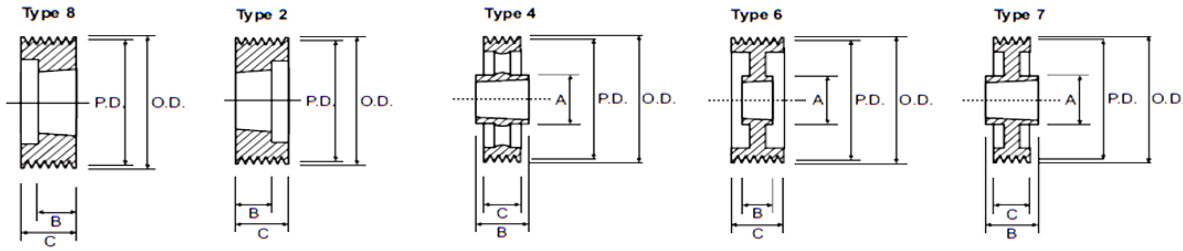

Part No.	O.D.	Type	Bush	A	B
SPA-80mm x 3	85.5	8	1210	-	25
SPA-85mm x 3	90.5	8	1210	-	25
SPA-90mm x 3	95.5	8	1610	-	25
SPA-95mm x 3	100.5	8	1610	-	25
SPA-100mm x 3	105.5	2	1610	-	25
SPA-106mm x 3	111.5	2	1610	-	25
SPA-112mm x 3	117.5	8	2012	-	32
SPA-118mm x 3	123.5	2	2012	-	32
SPA-125mm x 3	130.5	2	2012	-	32
SPA-132mm x 3	137.5	2	2012	-	32
SPA-140mm x 3	145.5	8	2517	-	45
SPA-150mm x 3	155.5	8	2517	-	45
SPA-160mm x 3	165.5	8	2517	-	45
SPA-170mm x 3	175.5	8	2517	-	45
SPA-180mm x 3	185.5	8	2517	-	45
SPA-190mm x 3	195.5	8	2517	-	45
SPA-200mm x 3	205.5	6	2517	123	45
SPA-224mm x 3	229.5	6	2517	124	45
SPA-236mm x 3	241.5	6	2517	120	45
SPA-250mm x 3	255.5	6	2517	124	45
SPA-280mm x 3	285.5	6	2517	124	45
SPA-315mm x 3	320.5	7	3020	159	51
SPA-355mm x 3	360.5	4	3020	159	51
SPA-400mm x 3	405.5	4	3020	159	51
SPA-500mm x 3	505.5	4	3020	159	51

Pitch Diameter = Outside Diameter - 5.5 mm

'C' = 50mm

- We supply Pulleys in straight bore with keyway as per customer requirements
- Material: C.I., M.S., Aluminium, Cast Aluminium, or other as per requirement
- We also manufacture all sizes which are not provided in table above.
- Customer Drawings and Specifications are most preferable.
- Pulley Type, Bush number, O.D., Bore, Width etc. will be as per customer design.
- We manufacture pulley in any type, any diameter, any no of groove as required.

SPA Taper Bore V Pulley 4 Groove

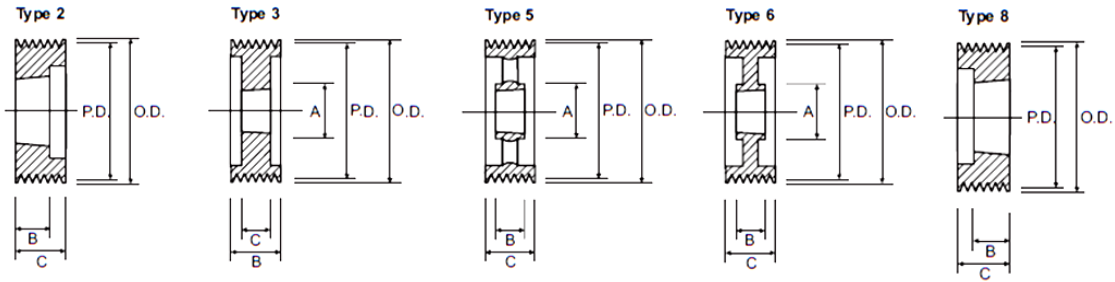

Part No.	O.D.	Type	Bush	A	B
SPA-80mm x 4	85.5	3	1615	-	38
SPA-85mm x 4	90.5	3	1615	-	38
SPA-90mm x 4	95.5	2	1615	-	38
SPA-95mm x 4	100.5	8	2012	-	32
SPA-100mm x 4	105.5	8	2012	-	32
SPA-106mm x 4	111.5	2	2012	-	32
SPA-112mm x 4	117.5	2	2012	-	32
SPA-118mm x 4	123.5	2	2517	-	45
SPA-125mm x 4	130.5	2	2517	-	45
SPA-132mm x 4	137.5	2	2517	-	45
SPA-140mm x 4	145.5	2	2517	-	45
SPA-150mm x 4	155.5	2	2517	-	45
SPA-160mm x 4	165.5	2	2517	-	45
SPA-170mm x 4	175.5	2	2517	-	45
SPA-180mm x 4	185.5	2	2517	-	45
SPA-190mm x 4	195.5	2	2517	-	45
SPA-200mm x 4	205.5	2	3020	-	51
SPA-224mm x 4	229.5	2	3020	-	51
SPA-236mm x 4	241.5	6	3020	147	51
SPA-250mm x 4	255.5	6	3020	159	51
SPA-280mm x 4	285.5	6	3020	159	51
SPA-315mm x 4	320.5	6	3020	159	51
SPA-355mm x 4	360.5	5	3020	159	51
SPA-400mm x 4	405.5	5	3020	159	51
SPA-500mm x 4	505.5	5	3020	159	51

Pitch Diameter = Outside Diameter – 5.5 mm

'C' = 65mm

- We supply Pulleys in straight bore with keyway as per customer requirements
- Material: C.I., M.S., Aluminium, Cast Aluminium, or other as per requirement
- We also manufacture all sizes which are not provided in table above.
- Customer Drawings and Specifications are most preferable.
- Pulley Type, Bush number, O.D., Bore, Width etc. will be as per customer design.
- We manufacture pulley in any type, any diameter, any no of groove as required.

SPA Taper Bore V Pulley 5 Groove



Delivering Quality Since 1997

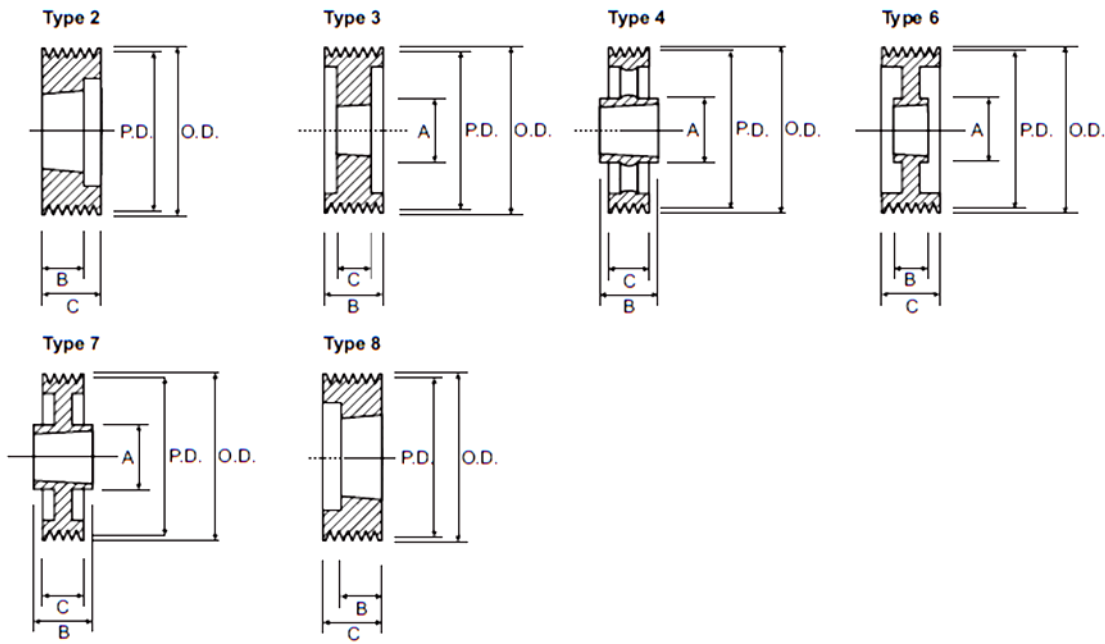

Part No.	O.D.	Type	Bush	A	B
SPA-100mm x 5	105.5	2	1615	-	38
SPA-106mm x 5	111.5	8	2012	-	32
SPA-112mm x 5	117.5	8	2012	-	32
SPA-118mm x 5	123.5	2	2012	-	32
SPA-125mm x 5	130.5	3	2012	-	32
SPA-132mm x 5	137.5	3	2517	-	45
SPA-140mm x 5	145.5	3	2517	-	45
SPA-150mm x 5	155.5	3	2517	-	45
SPA-160mm x 5	165.5	3	2517	-	45
SPA-170mm x 5	175.5	3	2517	-	45
SPA-180mm x 5	185.5	3	3020	-	51
SPA-190mm x 5	195.5	3	3020	-	51
SPA-200mm x 5	205.5	3	3020	-	51
SPA-224mm x 5	229.5	8	3020	-	51
SPA-236mm x 5	241.5	6	3020	145	51
SPA-250mm x 5	255.5	6	3020	159	51
SPA-280mm x 5	285.5	7	3535	178	89
SPA-315mm x 5	320.5	4	3535	178	89
SPA-355mm x 5	360.5	4	3535	178	89
SPA-400mm x 5	405.5	4	3535	178	89
SPA-500mm x 5	505.5	4	3535	178	89

Pitch Diameter = Outside Diameter - 5.5 mm

'C' = 80mm

- We supply Pulleys in straight bore with keyway as per customer requirements
- Material: C.I., M.S., Aluminium, Cast Aluminium, or other as per requirement
- We also manufacture all sizes which are not provided in table above.
- Customer Drawings and Specifications are most preferable.
- Pulley Type, Bush number, O.D., Bore, Width etc. will be as per customer design.
- We manufacture pulley in any type, any diameter, any no of groove as required.

SPB Taper Bore V Pulley 6 Groove

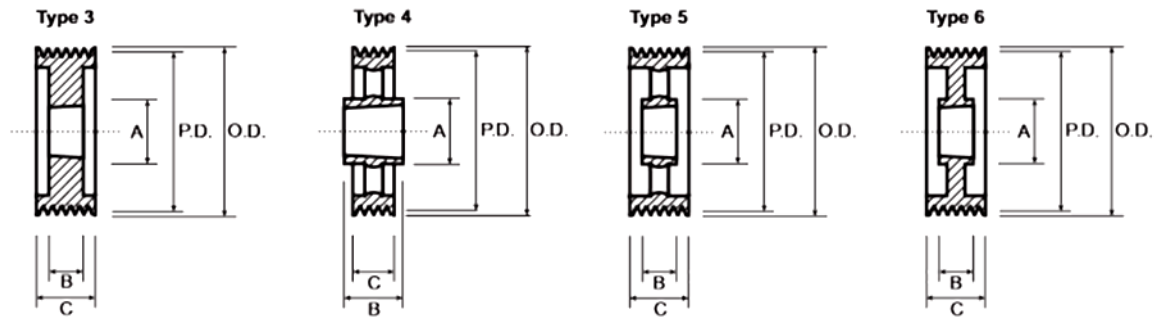

Part No.	O.D.	Type	Bush	A	B
SPB-140mm x 6	147	3	2517	-	45
SPB-150mm x 6	157	3	2517	-	45
SPB-160mm x 6	167	3	3020	-	51
SPB-170mm x 6	177	3	3020	-	51
SPB-180mm x 6	187	3	3020	-	51
SPB-190mm x 6	197	3	3020	-	51
SPB-200mm x 6	207	3	3020	-	51
SPB-212mm x 6	219	3	3535	-	89
SPB-224mm x 6	231	3	3535	-	89
SPB-236mm x 6	243	3	3535	-	89
SPB-250mm x 6	257	3	3535	-	89
SPB-280mm x 6	287	6	3535	187	89
SPB-300mm x 6	307	6	3535	187	89
SPB-315mm x 6	322	6	3535	187	89
SPB-355mm x 6	362	5	3535	187	89
SPB-400mm x 6	407	5	3535	187	89
SPB-450mm x 6	457	5	4040	216	102
SPB-500mm x 6	507	5	4040	216	102
SPB-560mm x 6	567	5	4040	216	102
SPB-630mm x 6	637	5	4040	216	102
SPB-800mm x 6	807	5	4545	242	114
SPB-1000mm x 6	1007	5	4545	242	114
SPB-1250mm x 6	1257	4	4545	242	114

Pitch Diameter = Outside Diameter – 7 mm

'C' = 120mm

- We supply Pulleys in straight bore with keyway as per customer requirements
- Material: C.I., M.S., Aluminium, Cast Aluminium, or other as per requirement
- We also manufacture all sizes which are not provided in table above.
- Customer Drawings and Specifications are most preferable.
- Pulley Type, Bush number, O.D., Bore, Width etc. will be as per customer design.
- We manufacture pulley in any type, any diameter, any no of groove as required.

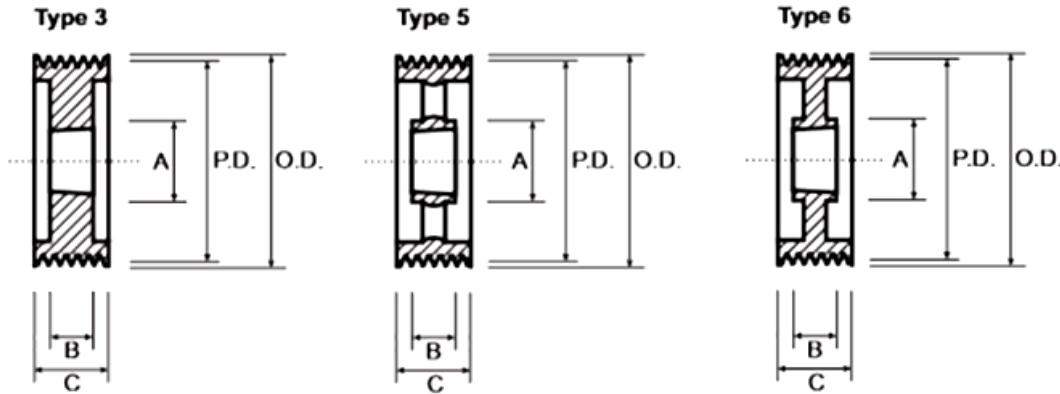

Part No.	O.D.	Type	Bush	A	B
SPB-180mm x 8	187	3	3030	-	76
SPB-190mm x 8	197	3	3030	-	76
SPB-200mm x 8	207	3	3535	-	89
SPB-212mm x 8	219	3	3535	-	89
SPB-224mm x 8	231	3	3535	-	89
SPB-236mm x 8	243	3	3535	-	89
SPB-250mm x 8	257	3	3535	-	89
SPB-280mm x 8	287	6	3535	187	89
SPB-300mm x 8	307	6	3535	187	89
SPB-315mm x 8	322	6	3535	187	89
SPB-355mm x 8	362	6	3535	187	89
SPB-400mm x 8	407	5	4040	200	102
SPB-450mm x 8	457	5	4040	216	102
SPB-500mm x 8	507	5	4040	216	102
SPB-560mm x 8	567	5	4545	242	114
SPB-630mm x 8	637	5	4545	242	114
SPB-800mm x 8	807	5	4545	242	114
SPB-1000mm x 8	1007	5	5050	267	127
SPB-1250mm x 8	1257	5	5050	267	127

Pitch Diameter = Outside Diameter - 7 mm

'C' = 158mm

- We supply Pulleys in straight bore with keyway as per customer requirements
- Material: C.I., M.S., Aluminium, Cast Aluminium, or other as per requirement
- We also manufacture all sizes which are not provided in table above.
- Customer Drawings and Specifications are most preferable.
- Pulley Type, Bush number, O.D., Bore, Width etc. will be as per customer design.
- We manufacture pulley in any type, any diameter, any no of groove as required.

SPC Taper Bore V Pulley 3 Groove

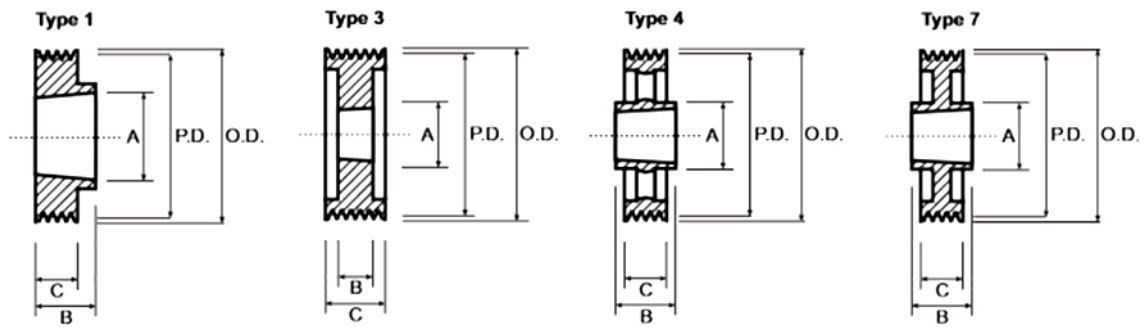

Part No.	O.D.	Type	Bush	A	B
SPC-200mm x 3	209.6	3	2517	-	45
SPC-212mm x 3	221.6	3	3020	-	51
SPC-224mm x 3	233.6	3	3020	-	51
SPC-236mm x 3	245.6	3	3020	-	51
SPC-250mm x 3	259.6	3	3020	-	51
SPC-265mm x 3	274.6	1	3535	179	89
SPC-280mm x 3	289.6	1	3535	187	89
SPC-300mm x 3	309.6	7	3535	187	89
SPC-315mm x 3	324.6	7	3535	187	89
SPC-335mm x 3	344.6	7	3535	187	89
SPC-355mm x 3	364.6	7	3535	187	89
SPC-375mm x 3	384.6	7	3535	187	89
SPC-400mm x 3	409.6	4	3535	187	89
SPC-425mm x 3	434.6	4	3535	187	89
SPC-450mm x 3	459.6	4	3535	187	89
SPC-475mm x 3	484.6	4	3535	187	89
SPC-500mm x 3	509.6	4	3535	187	89
SPC-530mm x 3	539.6	4	3535	187	89
SPC-560mm x 3	569.6	4	3535	187	89
SPC-630mm x 3	639.6	4	4040	216	102
SPC-800mm x 3	809.6	4	4545	242	114
SPC-1000mm x 3	1009.6	4	5050	267	127
SPC-1250mm x 3	1259.6	4	5050	267	127

Pitch Diameter = Outside Diameter - 9.6 mm

'C' = 85mm

- We supply Pulleys in straight bore with keyway as per customer requirements
- Material: C.I., M.S., Aluminium, Cast Aluminium, or other as per requirement
- We also manufacture all sizes which are not provided in table above.
- Customer Drawings and Specifications are most preferable.
- Pulley Type, Bush number, O.D., Bore, Width etc. will be as per customer design.
- We manufacture pulley in any type, any diameter, any no of groove as required.

SPC Taper Bore V Pulley 4 Groove



Delivering Quality Since 1997

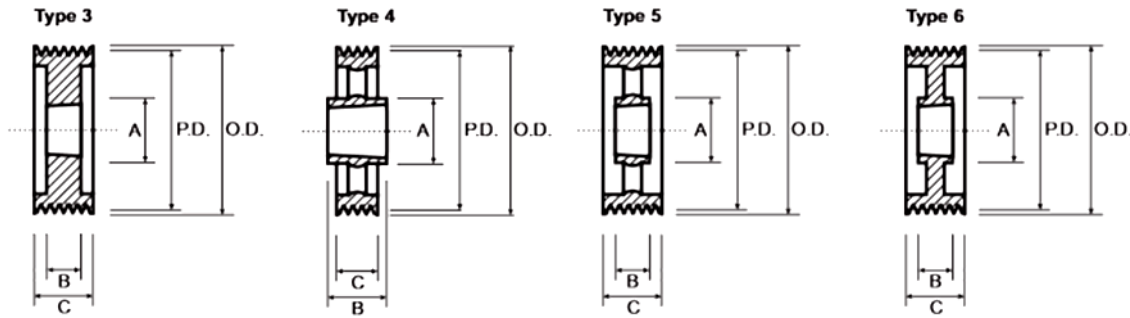

Part No.	O.D.	Type	Bush	A	B
SPC-200mm x 4	209.6	3	3020	-	51
SPC-212mm x 4	221.6	3	3020	-	51
SPC-224mm x 4	233.6	3	3535	-	89
SPC-236mm x 4	245.6	3	3535	-	89
SPC-250mm x 4	259.6	3	3535	-	89
SPC-265mm x 4	274.6	3	3535	-	89
SPC-280mm x 4	289.6	3	3535	-	89
SPC-300mm x 4	309.6	6	3535	187	89
SPC-315mm x 4	324.6	6	3535	187	89
SPC-335mm x 4	344.6	6	3535	187	89
SPC-355mm x 4	364.6	6	3535	187	89
SPC-375mm x 4	384.6	6	3535	187	89
SPC-400mm x 4	409.6	5	3535	187	89
SPC-425mm x 4	434.6	5	3535	187	89
SPC-450mm x 4	459.6	5	3535	187	89
SPC-475mm x 4	484.6	5	3535	187	89
SPC-500mm x 4	509.6	5	3535	187	89
SPC-530mm x 4	539.6	5	3535	187	89
SPC-560mm x 4	569.6	5	4040	216	102
SPC-630mm x 4	639.6	4	4545	242	114
SPC-800mm x 4	809.6	4	5050	267	127
SPC-1000mm x 4	1009.6	4	5050	267	127
SPC-1250mm x 4	1259.6	4	5050	267	127

Pitch Diameter = Outside Diameter - 9.6 mm

'C' = 111mm

- We supply Pulleys in straight bore with keyway as per customer requirements
- Material: C.I., M.S., Aluminium, Cast Aluminium, or other as per requirement
- We also manufacture all sizes which are not provided in table above.
- Customer Drawings and Specifications are most preferable.
- Pulley Type, Bush number, O.D., Bore, Width etc. will be as per customer design.
- We manufacture pulley in any type, any diameter, any no of groove as required.

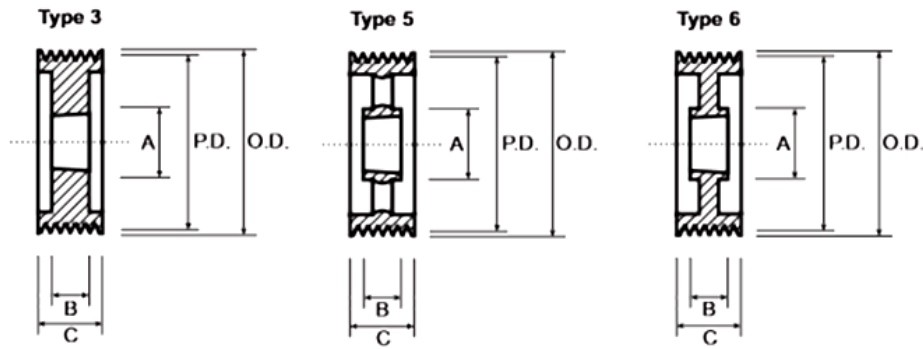

Part No.	O.D.	Type	Bush	A	B
SPC-200mm x 5	209.6	3	3535	-	89
SPC-212mm x 5	221.6	3	3535	-	89
SPC-224mm x 5	233.6	3	3535	-	89
SPC-236mm x 5	245.6	3	3535	-	89
SPC-250mm x 5	259.6	3	3535	-	89
SPC-265mm x 5	274.6	3	3535	-	89
SPC-280mm x 5	289.6	3	3535	-	89
SPC-300mm x 5	309.6	6	3535	187	89
SPC-315mm x 5	324.6	6	3535	187	89
SPC-335mm x 5	344.6	6	3535	187	89
SPC-355mm x 5	364.6	6	3535	187	89
SPC-375mm x 5	384.6	6	3535	187	89
SPC-400mm x 5	409.6	5	3535	187	89
SPC-425mm x 5	434.6	5	4040	216	102
SPC-450mm x 5	459.6	5	4040	216	102
SPC-475mm x 5	484.6	5	4040	216	102
SPC-500mm x 5	509.6	5	4040	216	102
SPC-530mm x 5	539.6	5	4040	216	102
SPC-560mm x 5	569.6	5	4545	242	114
SPC-630mm x 5	639.6	5	5050	267	127
SPC-800mm x 5	809.6	5	5050	267	127
SPC-1000mm x 5	1009.6	5	5050	267	127
SPC-1250mm x 5	1259.6	5	5050	267	127

Pitch Diameter = Outside Diameter - 9.6 mm

'C' = 136mm

- We supply Pulleys in straight bore with keyway as per customer requirements
- Material: C.I., M.S., Aluminium, Cast Aluminium, or other as per requirement
- We also manufacture all sizes which are not provided in table above.
- Customer Drawings and Specifications are most preferable.
- Pulley Type, Bush number, O.D., Bore, Width etc. will be as per customer design.
- We manufacture pulley in any type, any diameter, any no of groove as required.

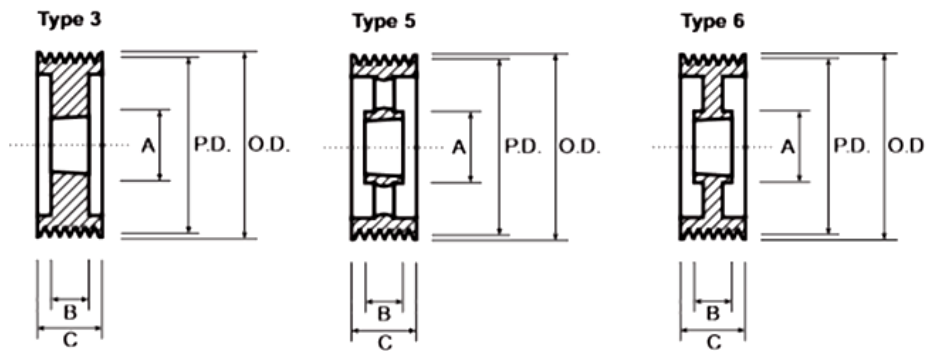

Part No.	O.D.	Type	Bush	A	B
SPC-200mm x 6	209.6	3	3535	-	89
SPC-212mm x 6	221.6	3	3535	-	89
SPC-224mm x 6	233.6	3	3535	-	89
SPC-236mm x 6	245.6	3	3535	-	89
SPC-250mm x 6	259.6	3	3535	-	89
SPC-265mm x 6	274.6	3	3535	-	89
SPC-280mm x 6	289.6	3	3535	-	89
SPC-300mm x 6	309.6	6	3535	187	89
SPC-315mm x 6	324.6	6	3535	187	89
SPC-335mm x 6	344.6	6	3535	187	89
SPC-355mm x 6	364.6	6	3535	187	89
SPC-375mm x 6	384.6	6	4040	216	102
SPC-400mm x 6	409.6	6	4040	216	102
SPC-425mm x 6	434.6	6	4545	242	114
SPC-450mm x 6	459.6	6	4545	242	114
SPC-475mm x 6	484.6	6	4545	242	114
SPC-500mm x 6	509.6	5	4545	242	114
SPC-530mm x 6	539.6	5	4545	242	114
SPC-560mm x 6	569.6	5	5050	267	127
SPC-630mm x 6	639.6	5	5050	267	127
SPC-800mm x 6	809.6	5	5050	267	127
SPC-1000mm x 6	1009.6	5	5050	267	127
SPC-1250mm x 6	1259.6	5	5050	267	127

Pitch Diameter = Outside Diameter - 9.6 mm

'C' = 162mm

- We supply Pulleys in straight bore with keyway as per customer requirements
- Material: C.I., M.S., Aluminium, Cast Aluminium, or other as per requirement
- We also manufacture all sizes which are not provided in table above.
- Customer Drawings and Specifications are most preferable.
- Pulley Type, Bush number, O.D., Bore, Width etc. will be as per customer design.
- We manufacture pulley in any type, any diameter, any no of groove as required.

SPC Taper Bore V Pulley 8 Groove

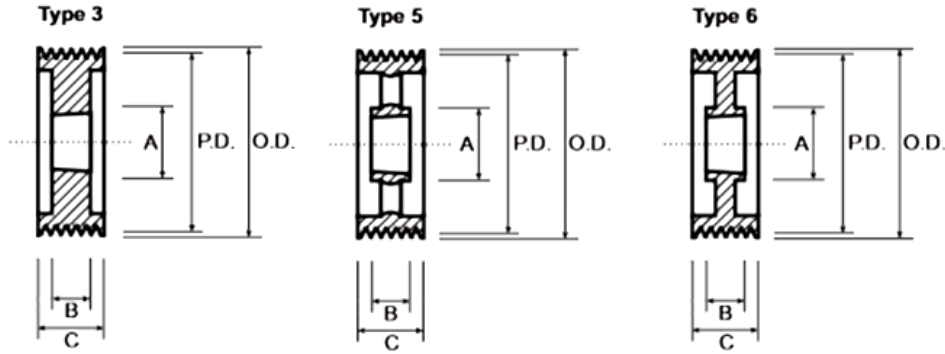

Part No.	O.D.	Type	Bush	A	B
SPC-200mm x 8	209.6	3	3535	-	89
SPC-212mm x 8	221.6	3	3535	-	89
SPC-224mm x 8	233.6	3	3535	-	89
SPC-236mm x 8	245.6	3	3535	-	89
SPC-250mm x 8	259.6	3	3535	-	89
SPC-265mm x 8	274.6	3	3535	-	89
SPC-280mm x 8	289.6	3	3535	-	89
SPC-300mm x 8	309.6	6	4040	216	102
SPC-315mm x 8	324.6	6	4040	216	102
SPC-335mm x 8	344.6	6	4040	216	102
SPC-355mm x 8	364.6	6	4040	216	102
SPC-375mm x 8	384.6	6	4545	242	114
SPC-400mm x 8	409.6	6	4545	242	114
SPC-425mm x 8	434.6	6	5050	267	127
SPC-450mm x 8	459.6	6	5050	267	127
SPC-475mm x 8	484.6	6	5050	267	127
SPC-500mm x 8	509.6	6	5050	267	127
SPC-530mm x 8	539.6	6	5050	267	127
SPC-560mm x 8	569.6	5	5050	267	127
SPC-630mm x 8	639.6	5	5050	267	127
SPC-800mm x 8	809.6	5	5050	267	127
SPC-1000mm x 8	1009.6	5	5050	267	127
SPC-1250mm x 8	1259.6	5	5050	267	127

Pitch Diameter = Outside Diameter - 9.6 mm

'C' = 213mm

- We supply Pulleys in straight bore with keyway as per customer requirements
- Material: C.I., M.S., Aluminium, Cast Aluminium, or other as per requirement
- We also manufacture all sizes which are not provided in table above.
- Customer Drawings and Specifications are most preferable.
- Pulley Type, Bush number, O.D., Bore, Width etc. will be as per customer design.
- We manufacture pulley in any type, any diameter, any no of groove as required.

SPZ Taper Bore V Pulley 1 Groove



Delivering Quality Since 1997

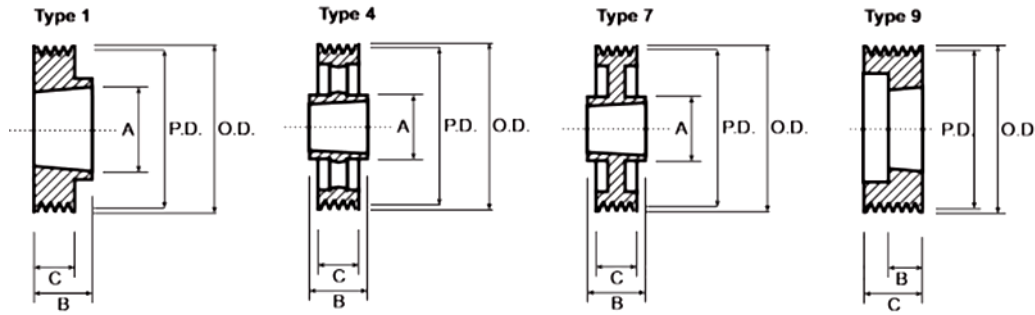

Part No.	O.D.	Type	Bush	A	B
SPZ- 56mm x 1	60	1	1008	60	37
SPZ- 60mm x 1	64	1	1008	58	22
SPZ- 63mm x 1	67	1	1108	56	22
SPZ- 67mm x 1	71	1	1108	60	22
SPZ- 71mm x 1	75	1	1108	60	22
SPZ- 75mm x 1	79	1	1108	60	22
SPZ- 80mm x 1	84	1	1210	75	25
SPZ- 85mm x 1	89	1	1210	80	25
SPZ- 90mm x 1	94	1	1210	80	25
SPZ- 95mm x 1	99	1	1210	85	25
SPZ- 100mm x 1	104	1	1210	85	25
SPZ- 106mm x 1	110	1	1610	92	25
SPZ- 112mm x 1	116	1	1610	92	25
SPZ- 118mm x 1	122	1	1610	92	25
SPZ- 125mm x 1	129	1	1610	92	25
SPZ- 132mm x 1	136	1	1610	92	25
SPZ- 140mm x 1	144	1	1610	92	25
SPZ- 150mm x 1	154	1	1610	92	25
SPZ- 160mm x 1	164	1	1610	92	25
SPZ- 180mm x 1	184	1	1610	92	25
SPZ- 200mm x 1	204	7	2012	112	32
SPZ- 224mm x 1	228	7	2012	112	32
SPZ- 250mm x 1	254	4	2012	112	32
SPZ- 280mm x 1	284	4	2012	112	32
SPZ- 315mm x 1	319	4	2012	112	32
SPZ- 355mm x 1	359	4	2012	112	32

Pitch Diameter = Outside Diameter - 4 mm

'C' = 16mm

- We supply Pulleys in straight bore with keyway as per customer requirements
- Material: C.I., M.S., Aluminium, Cast Aluminium, or other as per requirement
- We also manufacture all sizes which are not provided in table above.
- Customer Drawings and Specifications are most preferable.
- Pulley Type, Bush number, O.D., Bore, Width etc. will be as per customer design.
- We manufacture pulley in any type, any diameter, any no of groove as required.

SPZ Taper Bore V Pulley 2 Groove

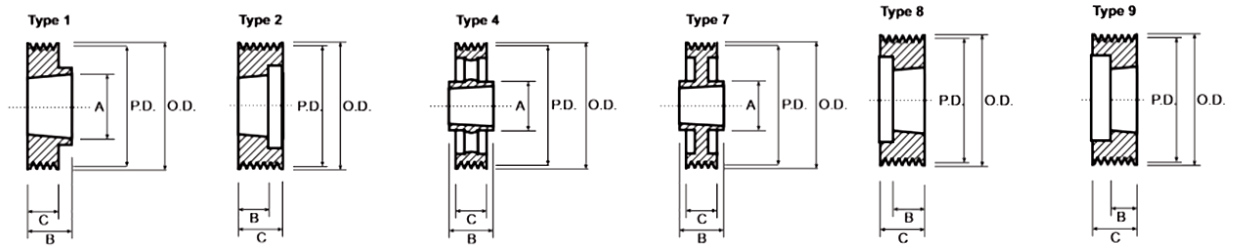

Part No.	O.D.	Type	Bush	A	B
SPZ- 56mm x 2	60	9	1108	-	49
SPZ- 60mm x 2	64	9	1108	-	28
SPZ- 63mm x 2	67	2	1108	-	28
SPZ- 67mm x 2	71	8	1108	-	28
SPZ- 71mm x 2	75	8	1108	-	28
SPZ- 75mm x 2	79	8	1210	-	28
SPZ- 80mm x 2	84	8	1210	-	28
SPZ- 85mm x 2	89	8	1610	-	28
SPZ- 90mm x 2	94	8	1610	-	28
SPZ- 95mm x 2	99	8	1610	-	28
SPZ- 100mm x 2	104	8	1610	-	28
SPZ- 106mm x 2	110	8	1610	-	28
SPZ- 112mm x 2	116	8	1610	-	28
SPZ- 118mm x 2	122	8	1610	-	25
SPZ- 125mm x 2	129	8	1610	-	25
SPZ- 132mm x 2	136	8	1610	-	25
SPZ- 140mm x 2	144	8	1610	-	25
SPZ- 150mm x 2	154	1	2012	112	32
SPZ- 160mm x 2	164	1	2012	112	32
SPZ- 180mm x 2	184	1	2012	112	32
SPZ- 200mm x 2	204	7	2012	112	32
SPZ- 224mm x 2	228	7	2012	112	32
SPZ- 250mm x 2	254	4	2012	112	32
SPZ- 280mm x 2	284	4	2012	112	32
SPZ- 315mm x 2	319	4	2012	112	32
SPZ- 355mm x 2	359	4	2012	112	32

Pitch Diameter = Outside Diameter - 4 mm

'C' = 28mm

- We supply Pulleys in straight bore with keyway as per customer requirements
- Material: C.I., M.S., Aluminium, Cast Aluminium, or other as per requirement
- We also manufacture all sizes which are not provided in table above.
- Customer Drawings and Specifications are most preferable.
- Pulley Type, Bush number, O.D., Bore, Width etc. will be as per customer design.
- We manufacture pulley in any type, any diameter, any no of groove as required.

SPZ Taper Bore V Pulley 3 Groove



Delivering Quality Since 1997

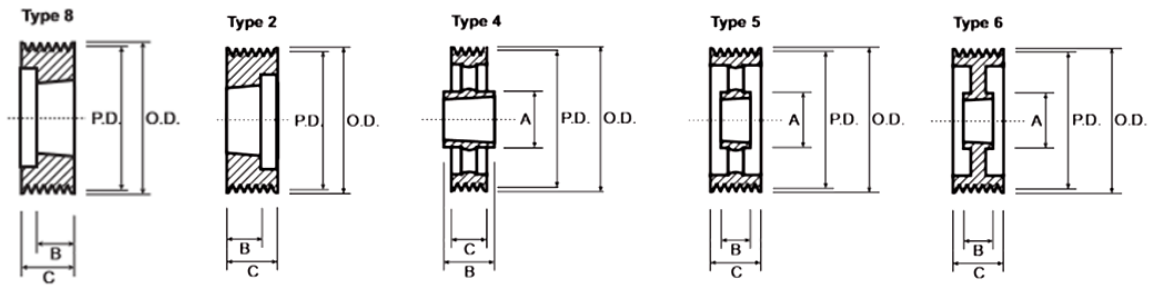

Part No.	O.D.	Type	Bush	A	B
SPZ- 63mm x 1	67	2	1108	-	22
SPZ- 67mm x 1	71	8	1108	-	22
SPZ- 71mm x 1	75	8	1108	-	22
SPZ- 75mm x 1	79	8	1210	-	25
SPZ- 80mm x 1	84	8	1210	-	25
SPZ- 85mm x 1	89	8	1610	-	25
SPZ- 90mm x 1	94	8	1610	-	25
SPZ- 95mm x 1	99	8	1610	-	25
SPZ- 100mm x 1	104	8	1610	-	25
SPZ- 106mm x 1	110	8	1610	-	25
SPZ- 112mm x 1	116	8	1610	-	32
SPZ- 118mm x 1	122	8	2012	-	32
SPZ- 125mm x 1	129	2	2012	-	32
SPZ- 132mm x 1	136	2	2012	-	32
SPZ- 140mm x 1	144	2	2012	-	32
SPZ- 150mm x 1	154	2	2012	-	32
SPZ- 160mm x 1	164	2	2012	-	32
SPZ- 180mm x 1	184	2	2012	-	32
SPZ- 200mm x 1	204	6	2012	112	32
SPZ- 224mm x 1	228	6	2012	112	32
SPZ- 250mm x 1	254	5	2012	112	32
SPZ- 280mm x 1	284	4	2012	124	45
SPZ- 315mm x 1	319	4	2012	124	45
SPZ- 355mm x 1	359	4	2517	124	45

Pitch Diameter = Outside Diameter - 4 mm

'C' = 40mm

- We supply Pulleys in straight bore with keyway as per customer requirements
- Material: C.I., M.S., Aluminium, Cast Aluminium, or other as per requirement
- We also manufacture all sizes which are not provided in table above.
- Customer Drawings and Specifications are most preferable.
- Pulley Type, Bush number, O.D., Bore, Width etc. will be as per customer design.
- We manufacture pulley in any type, any diameter, any no of groove as required.

Taper Lock Bush



Taper bushes are designed to give the following:

1. Easy assembly.
2. Rapid dismantling of the pulley and other transmission equipment.
3. No special tool requirement except hexagonal allen key.

A large range of bores are available off the shelf which ensures that an immediate assembly can be made, thus avoiding costly factory down-time. The bushes are machined with standard keyways. This, in addition to clamping screws is sufficient to meet the required torque.

Part No.		Stock Bore Sizes	OD	L
1008	MM	12, 14, 15, 16, 18, 19, 20, 22, 24, 25	35.0	20.3
	INCH	3/8", 1/2", 5/8", 3/4", 7/8", 1"		
1108	MM	12, 14, 15, 16, 18, 19, 20, 22, 24, 25, 28	38.0	20.3
	INCH	3/8", 1/2", 5/8", 3/4", 7/8", 1", 1 1/8"		
1210	MM	12, 14, 15, 16, 18, 19, 20, 22, 24, 25, 26, 28, 30, 32	47.5	25.4
	INCH	1/2", 5/8", 3/4", 7/8", 1", 1 1/8", 1 1/4"		
1215	MM	12, 14, 16, 18, 19, 20, 22, 24, 25, 28, 30, 32	47.5	38.1
	INCH	1/2", 5/8", 3/4", 7/8", 1", 1 1/8", 1 1/4"		
1610	MM	12, 14, 15, 16, 18, 19, 20, 22, 24, 25, 28, 30, 32, 35, 38, 40, 42	57.0	25.4
	INCH	1/2", 5/8", 3/4", 7/8", 1", 1 1/8", 1 1/4", 1 3/8", 1 5/8"		
1615	MM	12, 14, 16, 18, 19, 20, 22, 24, 25, 28, 30, 32, 35, 38, 40, 42	57.0	38.1
	INCH	1/2", 5/8", 3/4", 7/8", 1", 1 1/8", 1 1/4", 1 3/8", 1 1/2", 1 5/8"		
2012	MM	16, 19, 20, 22, 24, 25, 28, 30, 32, 35, 38, 40, 42, 45, 48, 50	70.0	31.8
	INCH	3/4", 7/8", 1", 1 1/8", 1 1/4", 1 3/8", 1 1/2", 1 5/8", 1 3/4", 1 7/8", 2"		
*2017	MM	19, 20, 22, 24, 32, 48	70.0	44.4
	INCH	3/4", 13/16", 7/8", 15/16", 1", 1 1/16", 1 1/8", 1 5/16", 1 3/8"		
2517	MM	19, 20, 22, 24, 25, 28, 30, 32, 35, 38, 40, 42, 45, 48, 50, 55, 60	85.5	44.5
	INCH	3/4", 7/8", 1", 1 1/8", 1 1/4", 1 3/8", 1 1/2", 1 5/8", 1 3/4", 1 7/8", 2", 2 1/8", 2 1/4", 2 3/8", 2 1/2"		
*2525	MM	19, 20, 22, 28	85.6	63.5
	INCH	3/4", 7/8", 1", 1 1/8"		
3020	MM	32, 35, 38, 40, 42, 45, 48, 50, 55, 60, 65, 70, 75	108.0	50.8
	INCH	1 1/4", 1 3/8", 1 1/2", 1 5/8", 1 3/4", 1 7/8", 2", 2 1/8", 2 1/4", 2 3/8", 2 1/2", 2 5/8", 2 3/4", 2 7/8", 3"		
3030	MM	32, 38, 40, 42, 45, 48, 55, 65, 70	108.0	76.2
	INCH	1 1/4", 1 3/8", 1 1/2", 1 5/8", 1 3/4", 1 7/8", 2 1/8", 2 3/8", 2 5/8", 2 3/4", 3"		
3535	MM	35, 38, 40, 42, 45, 48, 50, 55, 60, 65, 70, 75, 80, 85, 90	127.0	88.9
	INCH	1 1/2", 1 5/8", 1 3/4", 1 7/8", 2", 2 1/8", 2 1/4", 2 3/8", 2 1/2", 2 5/8", 2 3/4", 2 7/8", 3", 3 1/8", 3 1/4", 3 3/8", 3 1/2"		
4040	MM	40, 55, 60, 65, 70, 75, 80, 85, 95, 100	146.0	101.6
	INCH	1 3/8", 1 3/4", 1 7/8", 2", 2 1/8", 2 1/4", 2 1/2", 2 5/8", 3 1/2", 4"		
4545	MM	60, 65, 70, 75, 80, 85, 90, 95, 100, 105, 110	162.0	114.3
	INCH	3", 3 1/8", 3 1/4", 3 3/8", 3 1/2", 3 3/4", 4 1/2"		
5050	MM	70, 95, 100, 110, 115, 120, 125	177.5	127.0

* Discontinued size, only limited bore sizes available.

OD = Outside Diameter

L = Length Through Bore

Example
2517

The first 2 digit of the part number are the maximum Bore size in inches.

The second 2 digits of the part number are the length Through bore in inches.

2 1/2"
Maximum bore

1 3/4"
Length through Bore



Delivering Quality Since 1997



Muratech Engineering Company

**MANUFACTURER OF MECHANICAL POWER
TRANSMISSION PRODUCTS**

Address : Plot No. S5 & S6, Siddhivinayak industrial estate,
Near odhav police station, Odhav G.I.D.C., odhav,
Ahmedabad-382415, Gujarat, India.

Web : www.muracopower.co.in

Email : muracopower@hotmail.com / info@muracopower.co.in

Phone : +91 95868 23032 / +91 98253 48476 / +91 99745 83383