

Poly V Pulley Catalogue

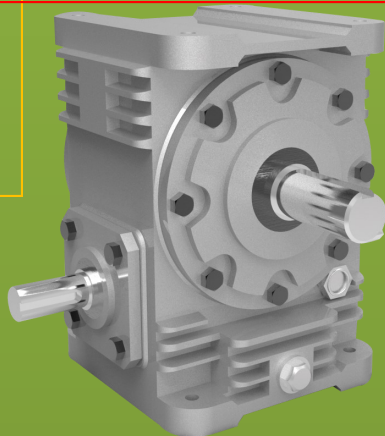
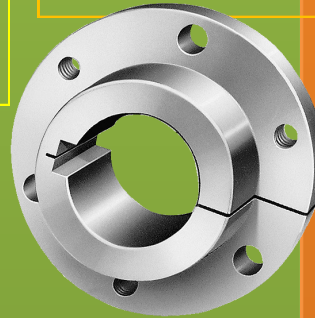
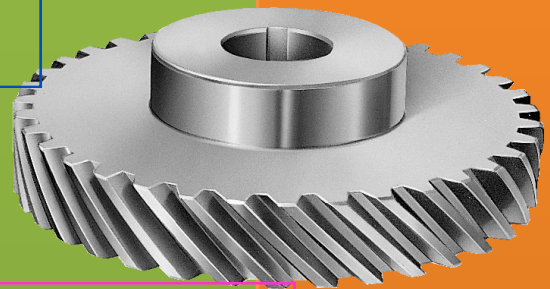
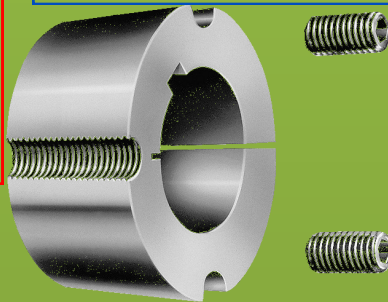
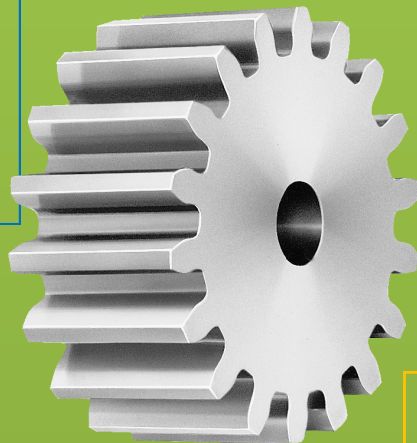
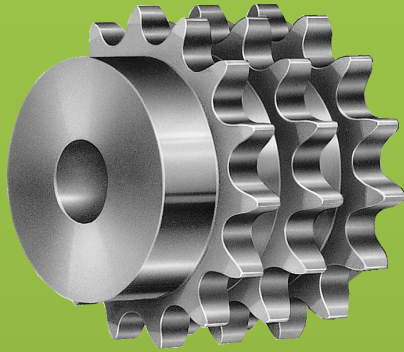

Poly V pulleys are manufactured according to ISO 9982 specification. This encompasses product designation, geometry, roughness & pulley run out.

Groove dimensions of Poly-V pulleys according to ISO 9982

	H	J	K	L	M
α	40 ± 0.5	40 ± 0.5	40 ± 0.5	40 ± 0.5	40 ± 0.5
P	1.50 ± 0.03	2.34 ± 0.03	3.56 ± 0.05	4.70 ± 0.05	9.40 ± 0.06
Tolerance ΣP	± 0.30	± 0.30	± 0.30	± 0.30	± 0.30
S min.	1.30	1.80	2.50	3.30	6.40
R1 Max.	0.30	0.40	0.50	0.40	0.75
R2 Min.	0.15	0.20	0.25	0.40	0.75
Ds	1.00 ± 0.01	1.50 ± 0.01	2.50 ± 0.01	3.50 ± 0.01	7.00 ± 0.01
$2X = D_p - D_e$	0.11	0.23	0.99	2.36	4.53

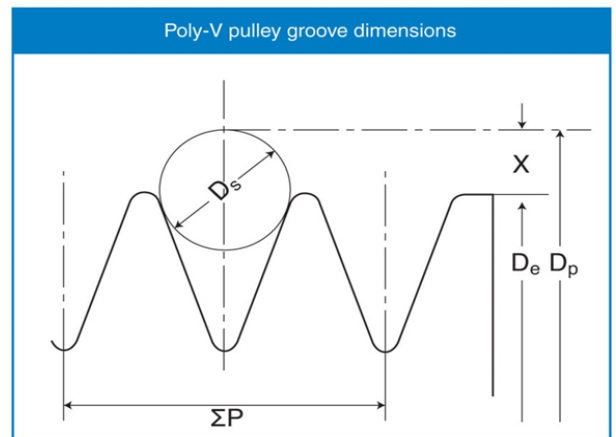
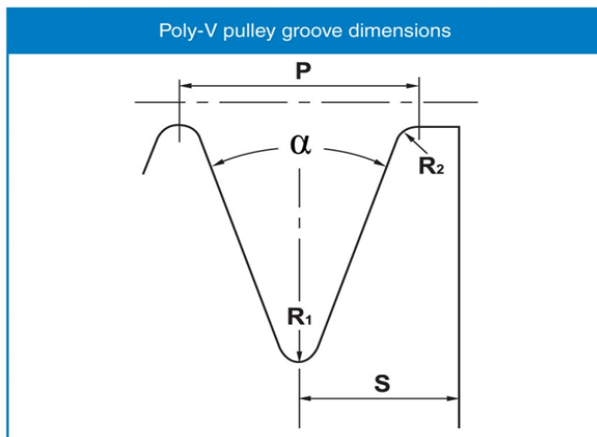

Poly V Pulley Section-J



Delivering Quality Since 1997

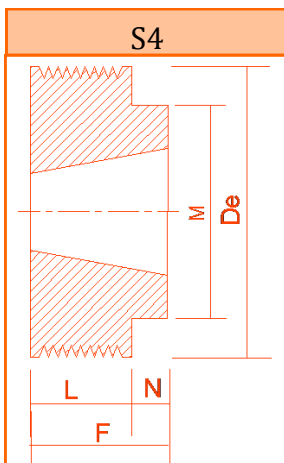
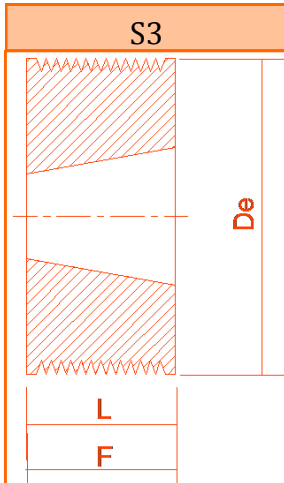
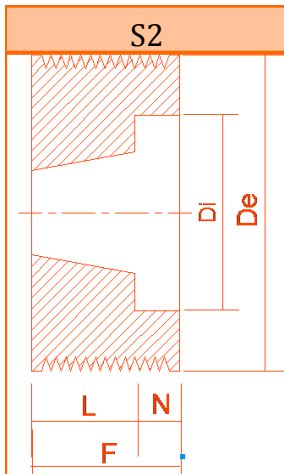
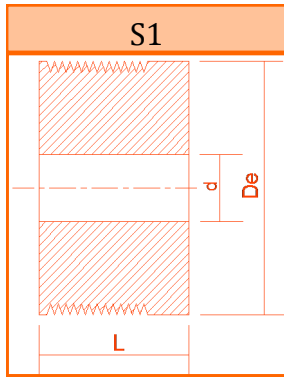

De	Groove Number	Bush Size	Style	F	L	N	M	Di	d
20	4	-	S1	13.5	22.5	-	-	-	5.0
	8	-	S1	23.0	32.0	-	-	-	5.0
	12	-	S1	32.5	41.5	-	-	-	5.0
	16	-	S1	42.0	51.0	-	-	-	5.0
	20	-	S1	52.0	61.0	-	-	-	5.0
25	4	-	S1	13.5	22.5	-	-	-	5.0
	8	-	S1	23.0	32.0	-	-	-	5.0
	12	-	S1	32.5	41.5	-	-	-	5.0
	16	-	S1	42.0	51.0	-	-	-	5.0
	20	-	S1	52.0	61.0	-	-	-	5.0
30	4	-	S1	13.5	22.5	-	-	-	9.5
	8	-	S1	23.0	32.0	-	-	-	9.5
	12	-	S1	32.5	41.5	-	-	-	9.5
	16	-	S1	42.0	51.0	-	-	-	9.5
	20	-	S1	52.0	61.0	-	-	-	9.5
35	4	-	S1	13.5	22.5	-	-	-	9.5
	8	-	S1	23.0	32.0	-	-	-	9.5
	12	-	S1	32.5	41.5	-	-	-	9.5
	16	-	S1	42.0	51.0	-	-	-	9.5
	20	-	S1	52.0	61.0	-	-	-	9.5
40	4	-	S1	13.5	22.5	-	-	-	12
	8	-	S1	23.0	32.0	-	-	-	12
	12	-	S1	32.5	41.5	-	-	-	12
	16	-	S1	42.0	51.0	-	-	-	12
	20	-	S1	52.0	61.0	-	-	-	12
45	4	-	S1	13.5	22.5	-	-	-	12
	8	-	S1	23.0	32.0	-	-	-	12
	12	-	S1	32.5	41.5	-	-	-	12
	16	-	S1	42.0	51.0	-	-	-	12
	20	-	S1	52.0	61.0	-	-	-	12
50	4	-	S1	13.5	22.5	-	-	-	12
	8	-	S1	23.0	32.0	-	-	-	12
	12	-	S1	32.5	41.5	-	-	-	12
	16	-	S1	42.0	51.0	-	-	-	12
	20	-	S1	52.0	61.0	-	-	-	12
56	4	1108	S4	13.5	23.0	9.5	50	-	-
	8	1108	S3	23.0	23.0	-	-	-	-
	12	-	S1	32.5	41.5	-	-	-	12
	16	-	S1	42.0	51.0	-	-	-	12
	20	-	S1	52.0	61.0	-	-	-	12
60	4	1108	S4	13.5	23.0	9.5	50	-	-
	8	1108	S3	23.0	23.0	-	-	-	-
	12	1108	S2	32.5	23.0	9.5	-	45	-
	16	-	S1	42.0	51.0	-	-	-	12
	20	-	S1	52.0	61.0	-	-	-	12
63	4	1108	S4	13.5	23.0	9.5	50	-	-
	8	1108	S3	23.0	23.0	-	-	-	-
	12	1108	S2	32.5	23.0	9.5	-	45	-
	16	-	S1	42.0	51.0	-	-	-	12
	20	-	S1	52.0	61.0	-	-	-	12
67	4	1108	S4	13.5	23.0	9.5	50	-	-
	8	1108	S3	23.0	23.0	-	-	-	-
	12	1108	S2	32.5	23.0	9.5	-	51	-
	16	-	S1	42.0	51.0	-	-	-	12
	20	-	S1	52.0	61.0	-	-	-	12

Poly V Pulley Section-J

De	Groove Number	Bush Size	Style	F	L	N	M	Di
71	4	1108	S4	13.5	23	9.5	60	-
	8	1108	S3	23.0	23	-	-	-
	12	1108	S2	32.5	23	9.5	-	55
	16	1215	S3	42.0	42	-	-	55
	20	1215	S2	52.0	42	10.0	-	55
75	4	1108	S4	13.5	23	9.5	60	-
	8	1108	S3	23.0	23	-	-	-
	12	1210	S2	32.5	26	6.5	-	59
	16	1610	S2	42.0	26	16.0	-	59
	20	1615	S2	52.0	42	10.0	-	59
80	4	1310	S4	13.5	26	12.5	70	-
	8	1310	S4	23.0	26	3.0	70	-
	12	1610	S2	32.5	26	6.5	-	64
	16	1610	S2	42.0	26	16.0	-	64
	20	1615	S2	52.0	42	10.0	-	64
85	4	1310	S4	13.5	26	12.5	70	-
	8	1310	S4	23.0	26	3.0	70	-
	12	1610	S2	32.5	26	6.5	-	69
	16	1610	S2	42.0	26	16.0	-	69
	20	1615	S2	52.0	42	10.0	-	69
90	4	1610	S4	13.5	26	12.5	82	-
	8	1610	S4	23.0	26	3.0	82	-
	12	1610	S2	32.5	26	6.5	-	74
	16	1610	S2	42.0	26	16.0	-	74
	20	1615	S2	52.0	42	10.0	-	74
95	4	1610	S4	13.5	26	12.5	82	-
	8	1610	S4	23.0	26	3.0	82	-
	12	1610	S2	32.5	26	6.5	-	79
	16	1610	S2	42.0	26	16.0	-	79
	20	1615	S2	52.0	42	10.0	-	79
100	4	1610	S4	13.5	26	12.5	82	-
	8	1610	S4	23.0	26	3.0	82	-
	12	1610	S2	32.5	26	6.5	-	82
	16	1610	S2	42.0	26	16.0	-	82
	20	1615	S2	52.0	42	10.0	-	82
106	4	1610	S4	13.5	26	12.5	88	-
	8	1610	S4	23.0	26	3.0	88	-
	12	1610	S2	32.5	26	6.5	-	88
	16	1610	S2	42.0	26	16.0	-	88
	20	1615	S2	52.0	42	10.0	-	88
112	4	1610	S4	13.5	26	12.5	90	-
	8	1610	S4	23.0	26	3.0	90	-
	12	1610	S2	32.5	26	6.5	-	94
	16	1610	S2	42.0	26	16.0	-	94
	20	1615	S2	52.0	42	10.0	-	94
118	4	1610	S4	13.5	26	12.5	90	-
	8	1610	S4	23.0	26	3.0	90	-
	12	2012	S2	32.5	32	0.5	-	98
	16	2012	S2	42.0	32	10.0	-	98
	20	2012	S2	52.0	32	20.0	-	98
125	4	1610	P3	13.5	26	12.5	90	109
	8	1610	P3	23.0	26	3.0	90	109
	12	2012	S2	32.5	32	0.5	-	105
	16	2012	S2	42.0	32	10.0	-	105
	20	2517	S2	52.0	45	7.0	-	105

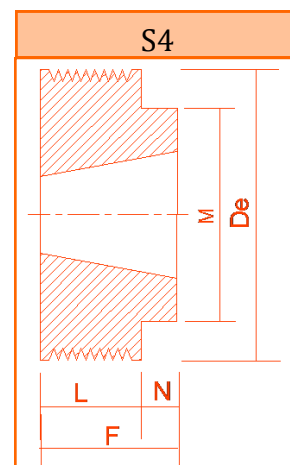
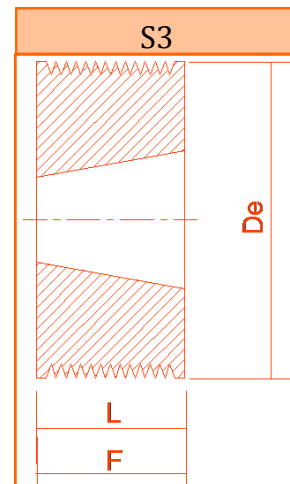
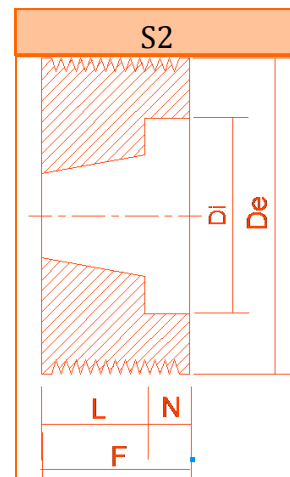
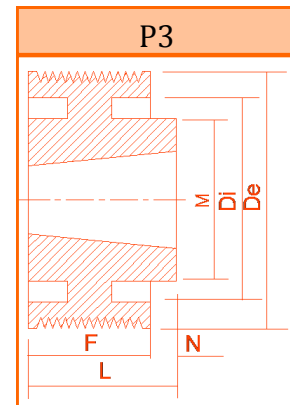

Poly V Pulley Section-J



Delivering Quality Since 1997

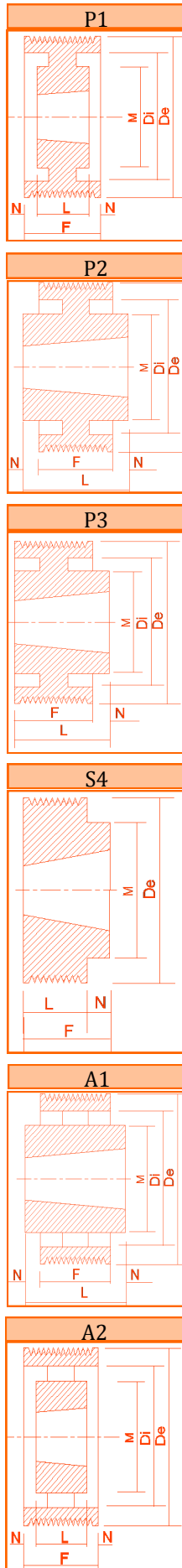

De	Groove Number	Bush Size	Style	F	L	N	M	Di
132	4	1610	P3	13.5	26	12.50	90	116
	8	1610	P3	23.0	26	3.00	90	116
	12	2012	S2	32.5	32	0.50	-	112
	16	2012	S2	42.0	32	10.00	-	112
	20	2517	S2	52.0	45	7.00	-	112
140	4	1610	P3	13.5	26	12.50	90	124
	8	1610	P3	23.0	26	3.00	90	124
	12	2517	S4	32.5	45	12.50	120	-
	16	2517	S4	42.0	45	3.00	120	-
	20	2517	S2	52.0	45	7.00	-	124
160	4	2012	P3	13.5	32	18.50	110	144
	8	2012	P3	23.0	32	9.00	110	144
	12	2517	P3	32.5	45	12.50	120	140
	16	2517	P3	42.0	45	3.00	120	140
	20	2517	S2	52.0	45	7.00	-	140
180	4	2012	P2	13.5	32	9.25	110	164
	8	2012	P2	23.0	32	4.50	110	164
	12	2517	P2	32.5	45	6.25	120	160
	16	2517	P2	42.0	45	1.50	120	160
	20	2517	P1	52.0	45	3.50	120	160
200	4	2012	P2	13.5	32	9.25	110	185
	8	2012	P2	23.0	32	4.50	110	185
	12	2517	P2	32.5	45	6.25	120	180
	16	2517	P2	42.0	45	1.50	120	180
	20	2517	P1	52.0	45	3.50	120	180
224	4	2012	P2	13.5	32	9.25	110	208
	8	2012	P2	23.0	32	4.50	110	208
	12	2517	P2	32.5	45	6.25	120	204
	16	2517	P2	42.0	45	1.50	120	204
	20	2517	P1	52.0	45	3.50	120	204
250	4	2012	A1	13.5	32	9.25	110	234
	8	2012	A1	23.0	32	4.50	110	234
	12	2517	P2	32.5	45	6.25	120	230
	16	2517	P2	42.0	45	1.50	120	230
	20	2517	P1	52.0	45	3.50	120	230
280	4	2012	A1	13.5	32	9.25	110	264
	8	2012	A1	23.0	32	4.50	110	264
	12	2517	A1	32.5	45	6.25	120	260
	16	2517	A1	42.0	45	1.50	120	260
	20	2517	A2	52.0	45	3.50	120	260
315	4	2012	A1	13.5	32	9.25	110	299
	8	2012	A1	23.0	32	4.50	110	299
	12	2517	A1	32.5	45	6.25	120	295
	16	2517	A1	42.0	45	1.50	120	295
	20	2517	A2	52.0	45	3.50	120	295
355	4	2517	A1	13.5	45	15.70	120	339
	8	2517	A1	23.0	45	11.00	120	339
	12	2517	A1	32.5	45	6.25	120	335
	16	3020	A1	42.0	52	5.00	146	335
	20	3020	A2	52.0	52	-	146	335
400	4	2517	A1	13.5	45	15.75	120	380
	8	2517	A1	23.0	45	11.00	120	380
	12	2517	A1	32.5	45	6.25	120	380
	16	3020	A1	42.0	52	5.00	146	380
	20	3020	A2	52.0	52	-	146	380

Poly V Pulley Section-K

De	Groove Number	Bush Size	Style	F	L	N	M	Di
80	4	1310	S4	22	26	4	78	-
	8	1310	S2	36	26	10	-	60
85	4	1310	S4	22	26	4	78	-
	8	1310	S2	36	26	10	-	65
90	4	1610	S4	22	26	4	86	-
	8	1610	S2	36	26	10	-	70
95	4	1610	S4	22	26	4	86	-
	8	1610	S2	36	26	10	-	75
100	4	1610	S4	22	26	4	86	-
	8	1610	S2	36	26	10	-	80
	12	1610	S2	50	26	24	-	80
	16	2012	S2	64	32	32	-	80
112	4	1610	S4	22	26	4	86	-
	8	1610	S2	36	26	10	-	92
	12	1610	S2	50	26	24	-	92
	16	2012	S2	64	32	32	-	92
118	4	1610	S4	22	26	4	86	-
	8	1610	S2	36	26	10	-	98
	12	1610	S2	50	26	24	-	98
	16	2012	S2	64	32	32	-	98
125	4	1610	S4	22	26	4	86	-
	8	1610	S2	36	26	10	-	105
	12	1610	S2	50	26	24	-	105
	16	2012	S2	64	32	32	-	105
132	4	1610	S4	22	26	4	86	-
	8	1610	S2	36	26	10	-	112
	12	2012	S2	50	32	18	-	112
	16	2012	S2	64	32	32	-	112
140	4	1610	S4	22	26	4	86	-
	8	2012	S2	36	32	10	-	120
	12	2012	S2	50	32	18	-	120
	16	2012	S2	64	32	32	-	120
150	4	2012	S4	22	32	10	104	-
	8	2012	S2	36	32	4	-	130
	12	2012	S2	50	32	18	-	130
	16	2517	S2	64	45	19	-	130
160	4	2012	S4	22	32	10	104	-
	8	2012	S2	36	32	4	-	140
	12	2012	S2	50	32	18	-	140
	16	2517	S2	64	45	19	-	140
170	4	2012	P3	22	32	10	104	150
	8	2012	S2	36	32	4	-	150
	12	2517	S2	50	45	5	-	150
	16	2517	S2	64	45	19	-	150
180	4	2012	P3	22	32	10	104	160
	8	2517	P3	36	45	9	117	160
	12	2517	P1	50	45	5	117	160
	16	2517	P1	64	45	19	117	160
190	4	2012	P3	22	32	10	104	170
	8	2517	P3	36	45	9	117	170
	12	2517	P1	50	45	5	117	170
	16	2517	P1	64	45	19	117	170
200	4	2012	P3	22	32	10	104	180
	8	2517	P3	36	45	9	117	180
	12	2517	P1	50	45	5	117	180
	16	2517	P1	64	45	19	117	180

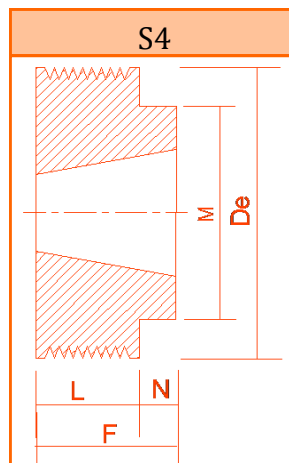
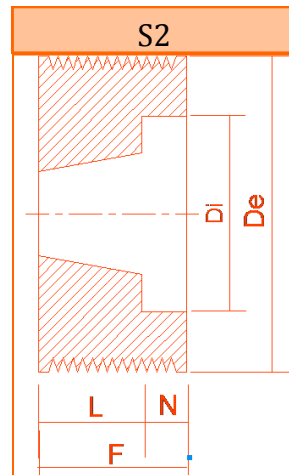
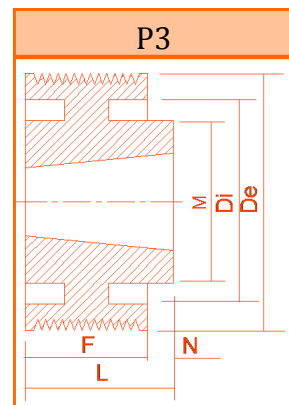
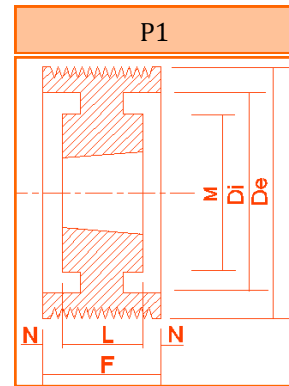

Poly V Pulley Section-K



Delivering Quality Since 1997

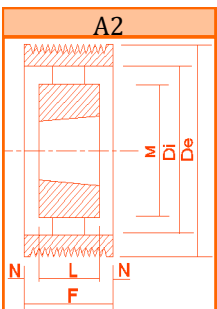
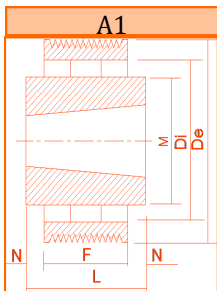
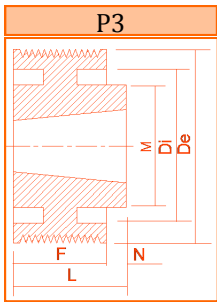
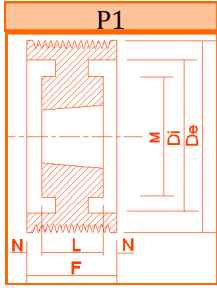

De	Groove Number	Bush Size	Style	F	L	N	M	Di
212	4	2012	P3	22	32	10	104	192
	8	2517	P3	36	45	9	117	192
	12	2517	P1	50	45	5	117	192
	16	2517	P1	64	45	19	117	192
224	4	2012	A1	22	32	10	104	204
	8	2517	P3	36	45	9	117	204
	12	2517	P1	50	45	5	117	204
	16	2517	P1	64	45	19	117	204
236	4	2012	A1	22	32	10	104	216
	8	2517	A1	36	45	9	117	216
	12	2517	A2	50	45	5	117	216
	16	2517	A2	64	45	19	117	216
250	4	2012	A1	22	32	10	104	230
	8	2517	A1	36	45	9	117	230
	12	2517	A2	50	45	5	117	230
	16	2517	A2	64	45	19	117	230
265	4	2517	A1	22	45	23	117	245
	8	2517	A1	36	45	9	117	245
	12	2517	A2	50	45	5	117	245
	16	3020	A2	64	51	13	144	245
280	4	2517	A1	22	45	23	117	260
	8	2517	A1	36	45	9	117	260
	12	2517	A2	50	45	5	117	260
	16	3020	A2	64	51	13	144	260
300	4	2517	A1	22	45	23	117	280
	8	2517	A1	36	45	9	117	280
	12	2517	A2	50	45	5	117	280
	16	3020	A2	64	51	13	144	280
315	4	2517	A1	22	45	23	117	290
	8	2517	A1	36	45	9	117	290
	12	3020	A1	50	51	1	144	290
	16	3020	A2	64	51	13	144	290
335	4	2517	A1	22	45	23	117	310
	8	2517	A1	36	45	9	117	310
	12	3020	A1	50	51	1	144	310
	16	3020	A2	64	51	13	144	310
355	4	2517	A1	22	45	23	117	330
	8	2517	A1	36	45	9	117	330
	12	3020	A1	50	51	1	144	330
	16	3020	A2	64	51	13	144	330
375	4	2517	A1	22	45	23	117	350
	8	3020	A1	36	51	15	144	350
	12	3020	A1	50	51	1	144	350
	16	3020	A2	64	51	13	144	350
400	4	2517	A1	22	45	23	117	375
	8	3020	A1	36	51	15	144	375
	12	3020	A1	50	51	1	144	375
	16	3535	A1	64	89	13	172	375
425	4	3020	A1	22	51	29	144	400
	8	3020	A1	36	51	15	144	400
	12	3020	A1	50	51	1	144	400
	16	3535	A1	64	89	13	172	400
450	4	3020	A1	22	51	29	144	425
	8	3020	A1	36	51	15	144	425
	12	3020	A1	50	51	1	144	425
	16	3535	A1	64	89	13	172	425

Poly V Pulley Section-L

De	Groove Number	Bush Size	Style	F	L	N	Di
75	6	1210	S2	38.5	26	12.5	56
	8	1210	S2	48.0	26	22.0	56
	10	1215	S2	57.0	42	15.0	56
	12	1215	S2	67.0	42	25.0	56
80	6	1210	S2	38.5	26	12.5	56
	8	1210	S2	48.0	26	22.0	56
	10	1215	S2	57.0	42	15.0	56
	12	1215	S2	67.0	42	25.0	56
85	6	1210	S2	38.5	26	12.5	61
	8	1210	S2	48.0	26	22.0	61
	10	1215	S2	57.0	42	15.0	61
	12	1215	S2	67.0	42	25.0	61
	16	1215	S5	86.0	42	22.0	61
90	6	1210	S2	38.5	26	12.5	66
	8	1210	S2	48.0	26	22.0	66
	10	1215	S2	57.0	42	15.0	66
	12	1215	S2	67.0	42	25.0	66
	16	1215	S5	86.0	42	22.0	66
95	6	1210	S2	38.5	26	12.5	71
	8	1210	S2	48.0	26	22.0	71
	10	1215	S2	57.0	42	15.0	71
	12	1215	S2	67.0	42	25.0	71
	16	1215	S5	86.0	42	22.0	71
100	6	1610	S2	38.5	26	12.5	76
	8	1610	S2	48.0	26	22.0	76
	10	2012	S2	57.0	32	25.0	79
	12	2012	S2	67.0	32	35.0	79
	16	2012	S5	86.0	32	27.0	79
106	6	1610	S2	38.5	26	12.5	82
	8	1610	S2	48.0	26	22.0	82
	10	2012	S2	57.0	32	25.0	82
	12	2012	S2	67.0	32	35.0	82
	16	2012	S5	86.0	32	27.0	82
112	6	1610	S2	38.5	26	12.5	88
	8	1610	S2	48.0	26	22.0	88
	10	2012	S2	57.0	32	25.0	88
	12	2012	S2	67.0	32	35.0	88
	16	2012	S5	86.0	32	27.0	88
118	6	2012	S2	38.5	32	6.5	94
	8	2012	S2	48.0	32	16.0	94
	10	2517	S5	57.0	45	6.0	97
	12	2517	S5	67.0	45	11.0	97
	16	2517	S5	86.0	45	20.5	97
	20	2517	S5	105.0	45	30.0	97
125	6	2012	S2	38.5	32	6.5	101
	8	2012	S2	48.0	32	16.0	101
	10	2517	S5	57.0	45	6.0	101
	12	2517	S5	67.0	45	11.0	101
	16	2517	S5	86.0	45	20.5	101
	20	2517	S5	105.0	45	30.0	101
132	6	2012	S2	38.5	32	6.5	108
	8	2012	S2	48.0	32	16.0	108
	10	2517	S5	57.0	45	6.0	108
	12	2517	S5	67.0	45	11.0	108
	16	2517	S5	86.0	45	20.5	108
	20	2517	S5	105.0	45	30.0	108

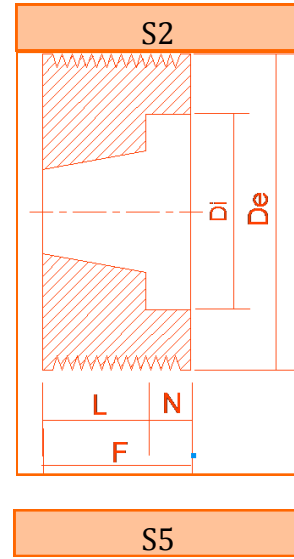

Poly V Pulley Section-L



Delivering Quality Since 1997

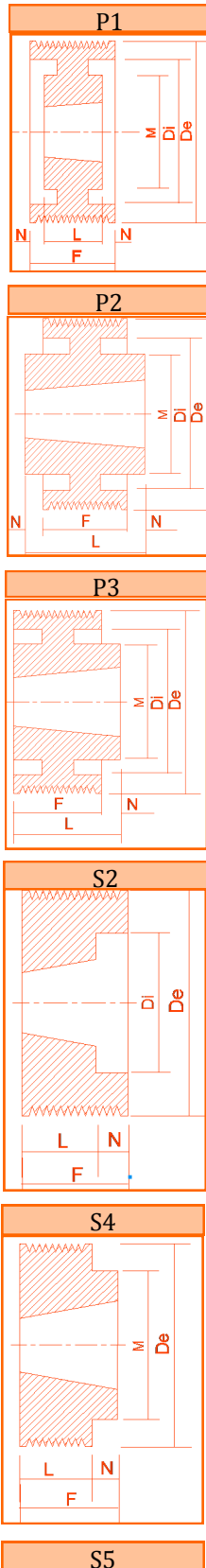

De	Groove Number	Bush Size	Style	F	L	N	M	Di
140	6	2517	S4	38.5	45	6.5	120	-
	8	2517	S2	48.0	45	3.0	-	116
	10	2517	S5	57.0	45	6.0	-	116
	12	2517	S5	67.0	45	11.0	-	116
	16	2517	S5	86.0	45	20.5	-	116
	20	3020	S5	105.0	52	26.5	-	116
150	6	2517	S4	38.5	45	6.5	120	-
	8	2517	S2	48.0	45	3.0	-	126
	10	2517	S5	57.0	45	6.0	-	126
	12	2517	S5	67.0	45	11.0	-	126
	16	2517	S5	86.0	45	20.5	-	126
	20	3020	S5	105.0	52	26.5	-	126
160	6	2517	S4	38.5	45	6.5	120	-
	8	2517	S2	48.0	45	3.0	-	136
	10	2517	S5	57.0	45	6.0	-	136
	12	2517	S5	67.0	45	11.0	-	136
	16	3020	S5	86.0	52	17.0	-	136
	20	3020	S5	105.0	52	26.5	-	136
170	6	2517	P3	38.5	45	6.5	120	146
	8	2517	S2	48.0	45	3.0	-	146
	10	2517	S5	57.0	45	6.0	-	146
	12	2517	S5	67.0	45	11.0	-	146
	16	3020	S5	86.0	52	17.0	-	146
	20	3020	S5	105.0	52	26.5	-	146
180	6	2517	P2	38.5	45	3.25	120	156
	8	2517	P1	48.0	45	1.50	120	156
	10	2517	P1	57.0	45	6.0	120	156
	12	2517	P1	67.0	45	11.0	120	156
	16	3020	S5	86.0	52	17.0	-	156
	20	3020	S5	105.0	52	26.5	-	156
190	6	2517	P2	38.5	45	3.25	120	166
	8	2517	P1	48.0	45	1.50	120	166
	10	2517	P1	57.0	45	6.0	120	166
	12	2517	P1	67.0	45	11.0	120	166
	16	3020	P1	86.0	52	17.0	146	166
	20	3020	P1	105.0	52	26.5	146	166
200	6	2517	P2	38.5	45	3.25	120	176
	8	2517	P1	48.0	45	1.5	120	176
	10	3020	P1	57.0	52	2.5	146	176
	12	3020	P1	67.0	52	7.5	146	176
	16	3020	P1	86.0	52	17.0	146	176
	20	3535	S5	105.0	89	8.0	-	176
212	6	2517	P2	38.5	45	3.25	120	188
	8	2517	P1	48.0	45	1.5	120	188
	10	3020	P1	57.0	52	2.5	146	188
	12	3020	P1	67.0	52	7.5	146	188
	16	3020	P1	86.0	52	17.0	146	188
	20	3535	S5	105.0	89	8.0	-	188
224	6	2517	P2	38.5	45	3.25	120	202
	8	2517	P1	48.0	45	1.5	120	202
	10	3020	P1	57.0	52	2.5	146	202
	12	3020	P1	67.0	52	7.5	146	202
	16	3020	P1	86.0	52	17.0	146	202
	20	3535	P1	105.0	89	8.0	178	202
236	6	2517	P2	38.5	45	3.25	120	214
	8	2517	P1	48.0	45	1.5	120	214
	10	3020	P1	57.0	52	2.5	146	214
	12	3020	P1	67.0	52	7.5	146	214
	16	3020	P1	86.0	52	17.0	146	214
	20	3535	P1	105.0	89	8.0	178	214

Poly V Pulley Section-L

De	Groove Number	Bush Size	Style	F	L	N	M	Di
250	6	2517	A1	38.5	45	3.25	120	228
	8	2517	P1	48.0	45	1.5	120	228
	10	3020	P1	57.0	52	2.5	146	228
	12	3020	P1	67.0	52	7.5	146	228
	16	3020	P1	86.0	52	17.0	146	228
280	20	3535	P1	105.0	89	8.0	178	228
	6	2517	P2	38.5	45	3.25	120	256
	8	3020	P2	48.0	52	2.0	146	256
	10	3020	P1	57.0	52	2.5	146	256
	12	3020	P1	67.0	52	7.5	146	256
315	16	3035	P2	86.0	89	1.5	178	256
	20	3535	P1	105.0	89	8.0	178	256
	6	2517	A1	38.5	45	3.25	120	285
	8	3020	A1	48.0	52	2.0	146	285
	10	3535	P2	57.0	89	16.0	178	285
	12	3535	P2	67.0	89	11.0	178	285
	16	3535	P2	86.0	89	1.5	178	285
355	20	4040	P1	105.0	102	1.5	215	325
	6	3020	A1	38.5	52	6.75	146	325
	8	3020	A1	48.0	52	2.0	146	325
	10	3535	A1	57.0	89	16.0	178	325
	12	3535	A1	67.0	89	11.0	178	325
400	16	3535	A1	86.0	89	1.5	178	325
	20	4040	P1	105.0	102	1.5	215	
	6	3020	A1	38.5	52	6.75	146	370
	8	3020	A1	48.0	52	2.0	146	370
	10	3535	A1	57.0	89	16.0	178	370
	12	3535	A1	67.0	89	11.0	178	370
	16	3535	A1	86.0	89	1.5	178	370
450	20	4040	A2	105.0	102	1.5	215	370
	6	3020	A1	38.5	52	6.75	146	420
	8	3020	A1	48.0	52	2.0	146	420
	10	3535	A1	57.0	89	16.0	178	420
	12	3535	A1	67.0	89	11.0	178	420
500	16	3535	A1	86.0	89	1.5	178	420
	20	4040	A1	105.0	102	1.5	215	420
	6	3020	A1	38.5	52	6.75	146	470
	8	3020	A1	48.0	52	2.0	146	470
	10	3535	A1	57.0	89	16.0	178	470
630	12	3535	A1	67.0	89	11.0	178	470
	16	3535	A1	86.0	89	1.5	178	470
	20	5050	A1	105.0	127	11.0	267	470
	6	3020	A1	38.5	52	6.75	146	600
	8	3020	A1	48.0	52	2.0	146	600
800	10	3535	A1	57.0	89	16.0	178	600
	12	3535	A1	67.0	89	11.0	178	600
	16	4040	A1	86.0	102	8.0	215	600
	20	5050	A1	105.0	127	11.0	267	600
	6	3535	A1	38.5	89	25.2	178	770
	8	3535	A1	48.0	89	20.5	178	770
	10	4040	A1	57.0	102	22.5	215	770
800	12	4040	A1	67.0	102	17.5	215	770
	16	5050	A1	86.0	127	20.5	267	770
	20	5050	A1	105.0	127	11.0	267	770

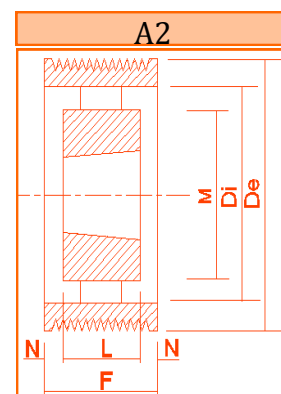
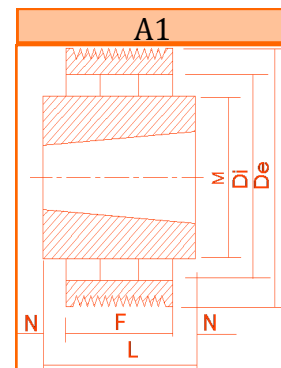
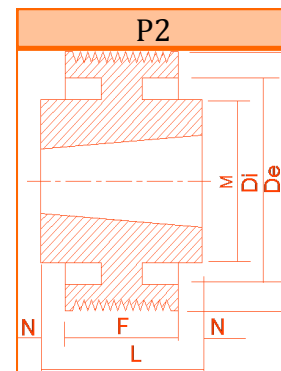
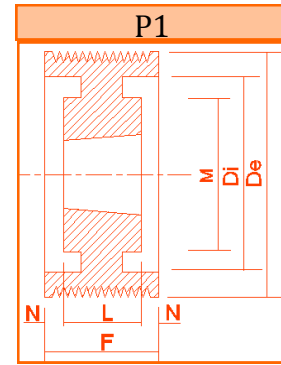

Taper Lock Bush



Delivering Quality Since 1997

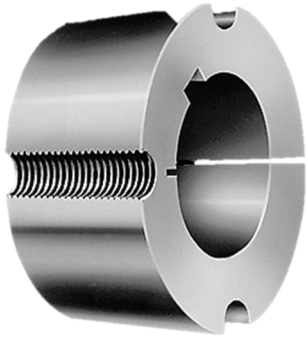

Taper bushes are designed to give the following:

1. Easy assembly.
2. Rapid dismantling of the pulley and other transmission equipment.
3. No special tool requirement except hexagonal allen key.

A large range of bores are available off the shelf which ensures that an immediate assembly can be made, thus avoiding costly factory down-time.

The bushes are machined with standard keyways. This, in addition to clamping screws is sufficient to meet the required torque.

Part No.		Stock Bore Sizes	OD	L
1008	MM INCH	12, 14, 15, 16, 18, 19, 20, 22, 24, 25 3/8", 1/2", 5/8", 3/4", 7/8", 1"	35.0	20.3
1108	MM INCH	12, 14, 15, 16, 18, 19, 20, 22, 24, 25, 28 3/8", 1/2", 5/8", 3/4", 7/8", 1", 1 1/8"	38.0	20.3
1210	MM INCH	12, 14, 15, 16, 18, 19, 20, 22, 24, 25, 26, 28, 30, 32 1/2", 5/8", 3/4", 7/8", 1", 1 1/8", 1 1/4"	47.5	25.4
1215	MM INCH	12, 14, 16, 18, 19, 20, 22, 24, 25, 28, 30, 32 1/2", 5/8", 3/4", 7/8", 1", 1 1/8", 1 1/4"	47.5	38.1
1610	MM INCH	12, 14, 15, 16, 18, 19, 20, 22, 24, 25, 28, 30, 32, 35, 38, 40, 42 1/2", 5/8", 3/4", 7/8", 1", 1 1/8", 1 1/4", 1 3/8", 1 5/8"	57.0	25.4
1615	MM INCH	12, 14, 16, 18, 19, 20, 22, 24, 25, 28, 30, 32, 35, 38, 40, 42 1/2", 5/8", 3/4", 7/8", 1", 1 1/8", 1 1/4", 1 3/8", 1 1/2", 1 5/8"	57.0	38.1
2012	MM INCH	16, 19, 20, 22, 24, 25, 28, 30, 32, 35, 38, 40, 42, 45, 48, 50 3/4", 7/8", 1", 1 1/8", 1 1/4", 1 3/8", 1 1/2", 1 5/8", 1 3/4", 1 7/8", 2"	70.0	31.8
*2017	MM INCH	19, 20, 22, 24, 32, 48 3/4", 13/16", 7/8", 15/16", 1", 1 1/16", 1 1/8", 1 5/16", 1 3/8"	70.0	44.4
2517	MM INCH	19, 20, 22, 24, 25, 28, 30, 32, 35, 38, 40, 42, 45, 48, 50, 55, 60 3/4", 7/8", 1", 1 1/8", 1 1/4", 1 3/8", 1 1/2", 1 5/8", 1 3/4", 1 7/8", 2", 2 1/8", 2 1/4", 2 3/8", 2 1/2"	85.5	44.5
*2525	MM INCH	19, 20, 22, 28 3/4", 7/8", 1", 1 1/8"	85.6	63.5
3020	MM INCH	32, 35, 38, 40, 42, 45, 48, 50, 55, 60, 65, 70, 75 1 1/4", 1 3/8", 1 1/2", 1 5/8", 1 3/4", 1 7/8", 2", 2 1/8", 2 1/4", 2 3/8", 2 1/2", 2 5/8", 2 3/4", 2 7/8", 3"	108.0	50.8
3030	MM INCH	32, 38, 40, 42, 45, 48, 55, 65, 70 1 1/4", 1 3/8", 1 1/2", 1 5/8", 1 3/4", 1 7/8", 2 1/8", 2 3/8", 2 5/8", 2 3/4", 3"	108.0	76.2
3535	MM INCH	35, 38, 40, 42, 45, 48, 50, 55, 60, 65, 70, 75, 80, 85, 90 1 1/2", 1 5/8", 1 3/4", 1 7/8", 2", 2 1/8", 2 1/4", 2 3/8", 2 1/2", 2 5/8", 2 3/4", 2 7/8", 3", 3 1/8", 3 1/4", 3 3/8", 3 1/2"	127.0	88.9
4040	MM INCH	40, 55, 60, 65, 70, 75, 80, 85, 95, 100 1 3/8", 1 3/4", 1 7/8", 2", 2 1/8", 2 1/4", 2 1/2", 2 5/8", 3 1/2", 4"	146.0	101.6
4545	MM INCH	60, 65, 70, 75, 80, 85, 90, 95, 100, 105, 110 3", 3 1/8", 3 1/4", 3 3/8", 3 1/2", 3 3/4", 4 1/2"	162.0	114.3
5050	MM	70, 95, 100, 110, 115, 120, 125	177.5	127.0

* Discontinued size, only limited bore sizes available.

OD = Outside Diameter
L = Length Through Bore

Example
2517

The first 2 digit of the part number are the maximum Bore size in inches.

2 1/2"

Maximum bore

1 3/4"

Length through Bore

The second 2 digits of the part number are the length Through bore in inches.



Delivering Quality Since 1997



Muratech Engineering Company

**MANUFACTURER OF MECHANICAL POWER
TRANSMISSION PRODUCTS**

Address : Plot No. S5 & S6, Siddhivinayak industrial estate,
Near odhav police station, Odhav G.I.D.C., odhav,
Ahmedabad-382415, Gujarat, India.

Web : www.muracopower.co.in

Email : muracopower@hotmail.com / info@muracopower.co.in

Phone : +91 95868 23032 / +91 98253 48476 / +91 99745 83383